

# BDS 275/BDS 277/BDS 575/BDS 577

Blu-ray Disc Receiver

Quick-Start Guide

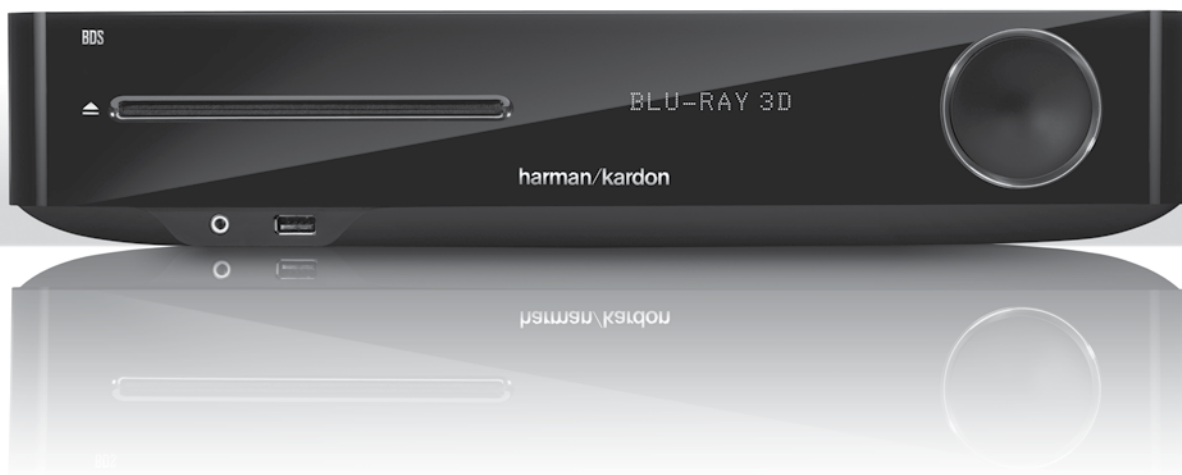















**harman/kardon**<sup>®</sup>  
by HARMAN

**Thank you for choosing a Harman Kardon® product!**

This quick-start guide contains all the information you need to connect and set up your new BDS Blu-ray Disc™ receiver.

To conserve our natural resources, your BDS receiver does not include a printed owner's manual. An owner's manual containing complete information about operating all of your new Blu-ray Disc receiver's features is available at our Web site. Go to [www.harmankardon.com](http://www.harmankardon.com) and download the *BDS Blu-ray Disc Receiver Owner's Manual*.

Your BDS receiver is designed to be compatible with region management information that is encoded on most Blu-ray Disc and DVD recordings. Your receiver will only play discs that contain region coding for the area where your receiver was shipped and intended for sale:

Area Where Sold	Blu-ray Disc Region Code	DVD Region Code
USA, Canada		
Europe, Middle East		
Korea, S.E. Asia		
Mexico, Latin America		
Australia, New Zeland		
Russia, India		
China		

For example, BDS receivers shipped to and sold in the USA will only play Blu-ray Discs that contain region code A and DVD discs that contain region code 1.

**Connections**

**Connect the Speakers**

**CAUTION:** Before making any connections to the BDS receiver, ensure that the receiver's AC cord is unplugged from the receiver and the AC outlet. Making speaker connections with the receiver plugged in and turned on could damage your speakers.

Your BDS receiver has color-coded speaker terminals:

**BDS 275/BDS 277**

white	left channel (+)
red	right channel (+)
black	(-) on both channels

**BDS 575/BDS 577**

white	front left (+)
red	front right (+)
blue	surround left (+)
gray	surround right (+)
green	center (+)
black	(-) on all channels

Most speakers use red to denote the (+) terminal and black for the (-) terminal. Be sure to connect each speaker identically: (+) on the speaker to (+) on the receiver and (-) on the speaker to (-) on the receiver. Miswiring one or more speakers results in thin sound, weak bass and a poor stereo image.

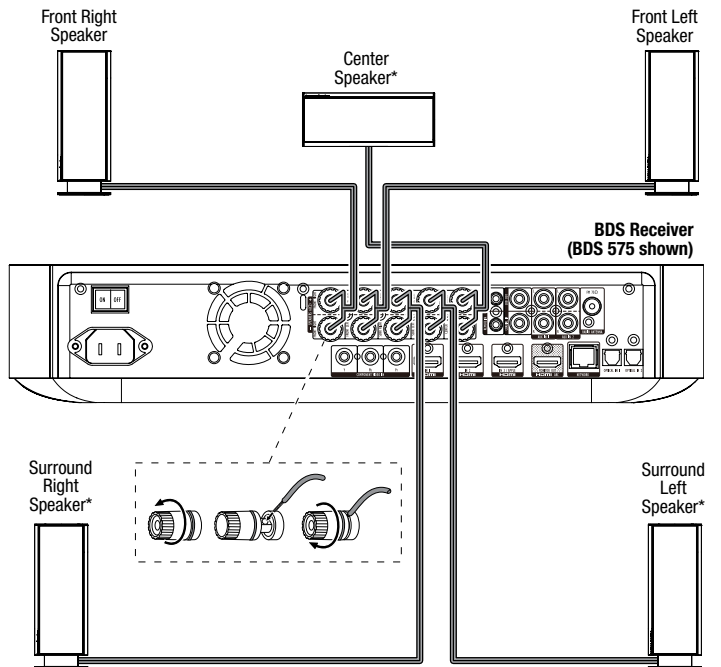

\* Used only with BDS 575/BDS 577 receiver

**IMPORTANT:** Make sure the (+) and (-) bare wires do not touch each other or any metal object on the BDS receiver's rear panel. Touching wires can cause a short circuit that can damage the BDS receiver.

### Connect the Subwoofer

**IMPORTANT:** Do not plug the subwoofer's AC power cord into an AC outlet at this time.

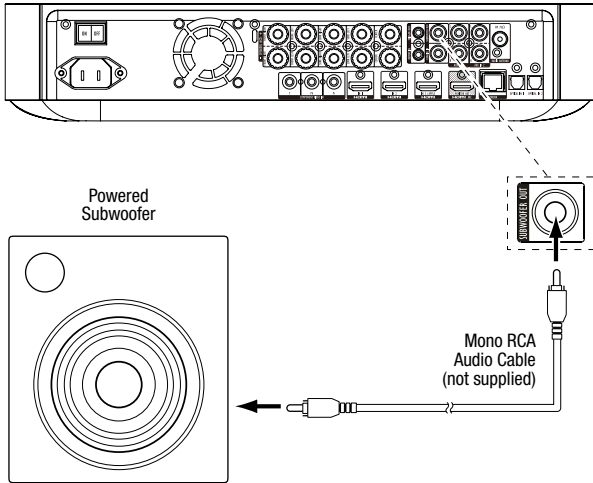

### Connect to Your Wired Home Network

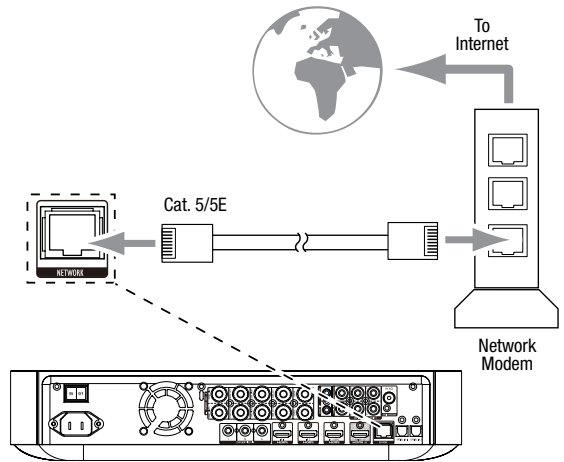

### Connect the Radio Antenna

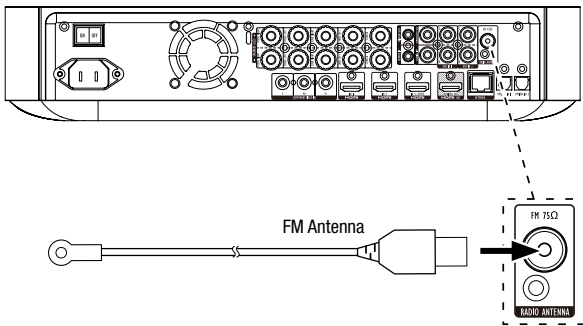

### Connecting Your HDMI® Source Devices

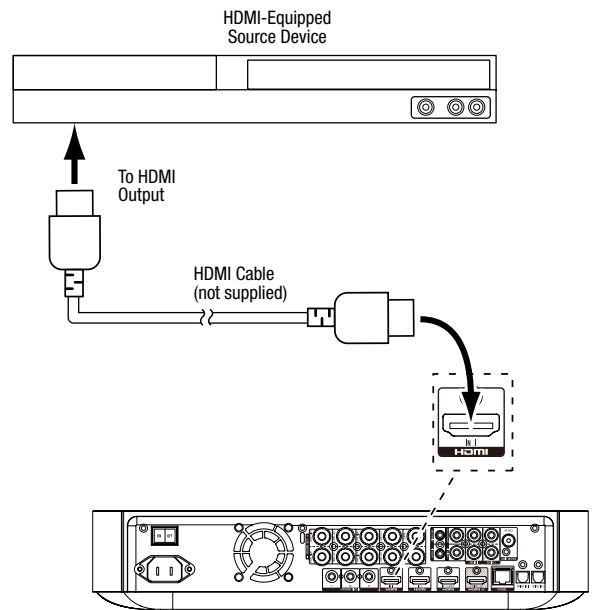

### Connect a TV or Video Display

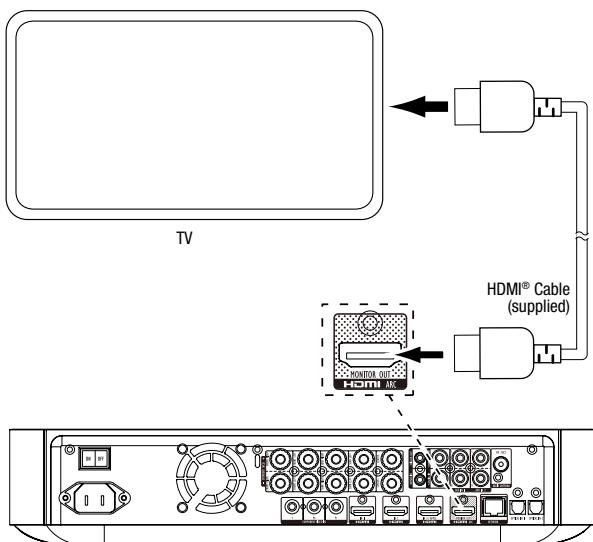

**NOTE:** If your TV supports the HDMI Audio Return Channel and you access digital TV channels from your TV's built-in tuner or you have other sources already connected directly to your TV, you can feed their sound to the BDS receiver via the HDMI Monitor Out connector's Audio Return Channel, and they will not require additional connections to the receiver.

## Connecting Your Component Video Source Device

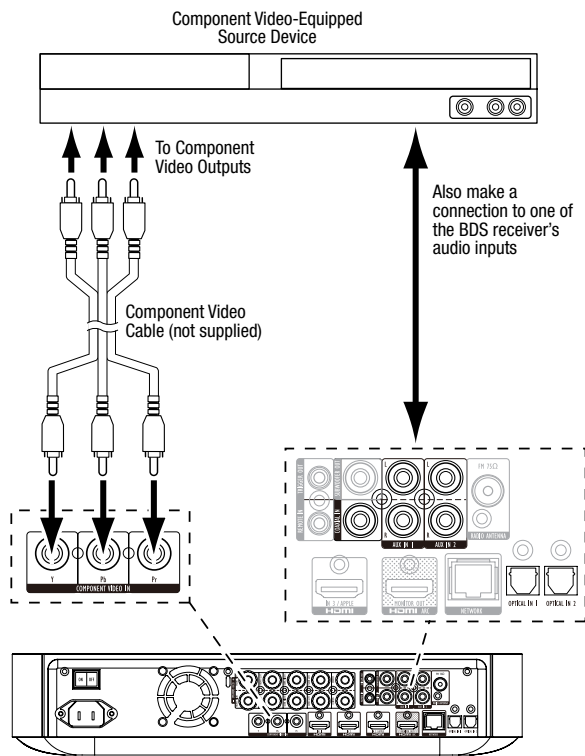

## Connecting Your Coaxial Digital Audio Source Device

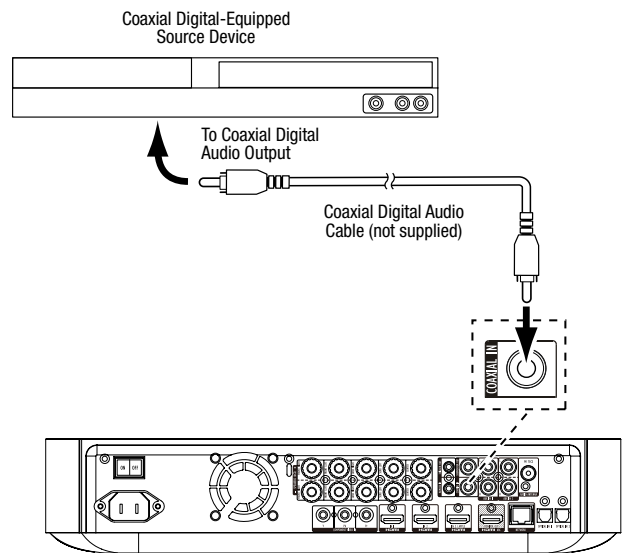

## Connecting Your Analog Audio Source Devices

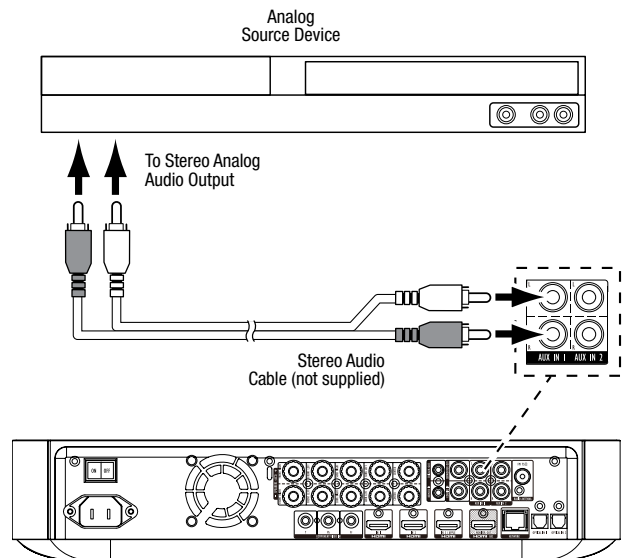

## Connecting Your Optical Digital Audio Source Devices

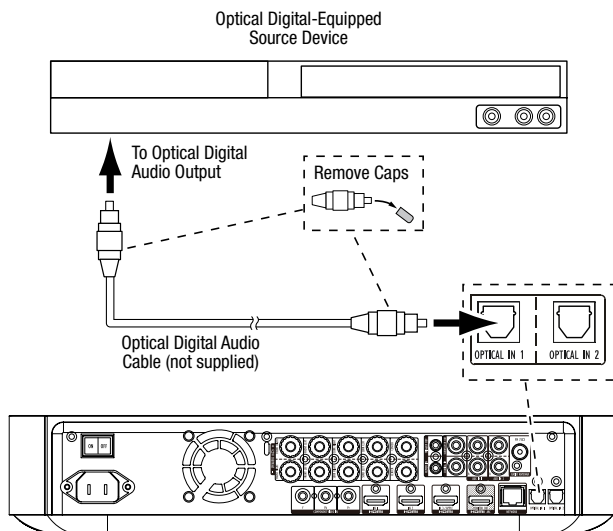

### Connect the AC Power

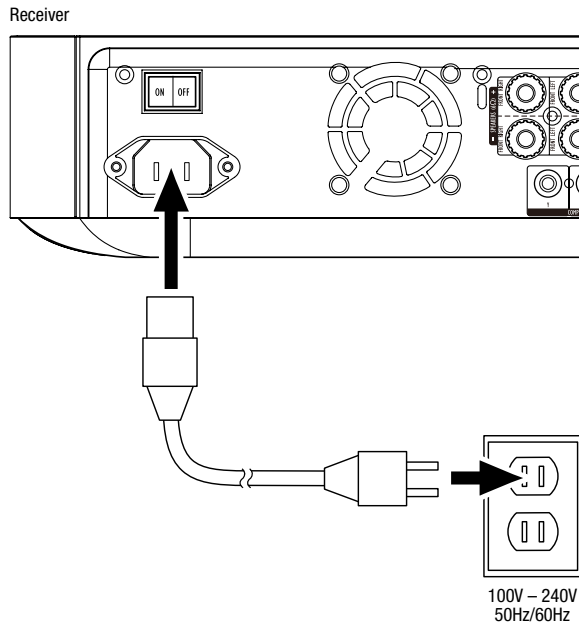

### Set Up the Receiver

#### Install the Batteries in the Remote Control

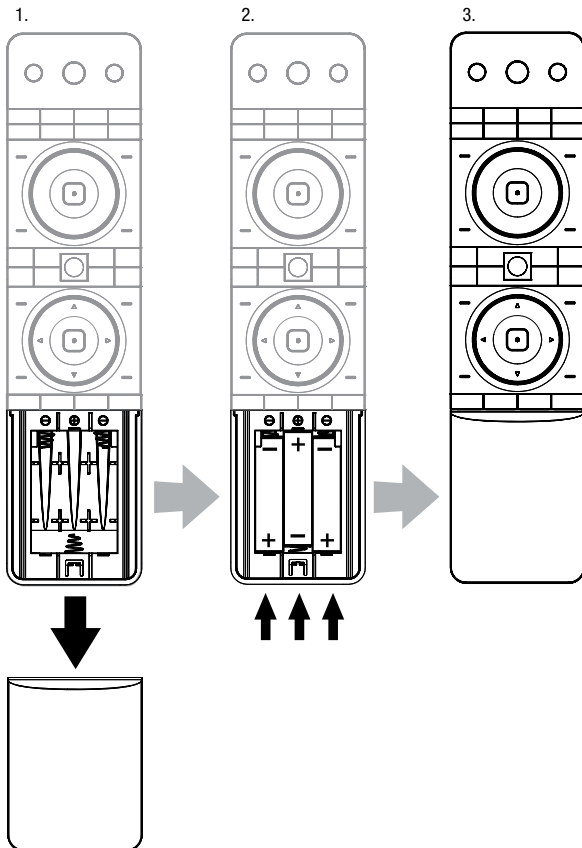

### Turn On the Receiver

Set the receiver's Main Power switch in the "On" position.

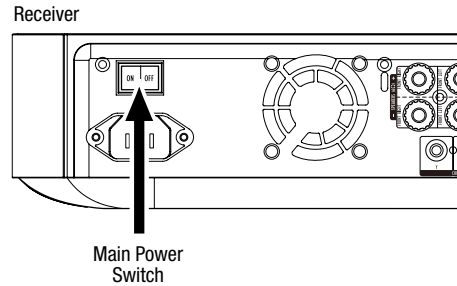

To set up your BDS receiver you will use the remote to navigate through the on-screen menus and to make selections from them.

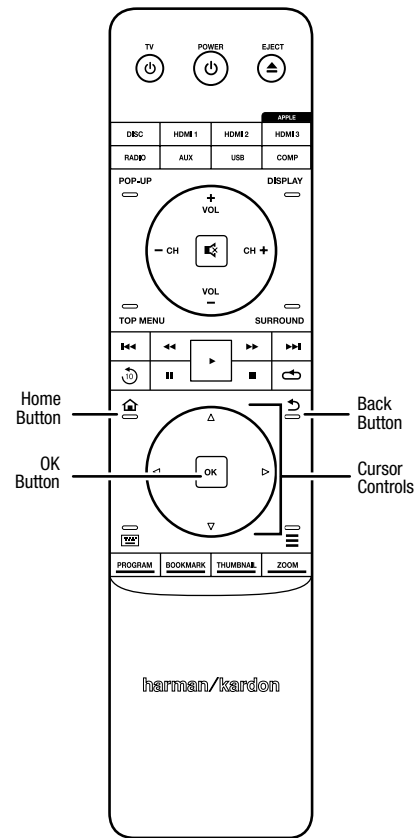

- Use the Cursor Up/Down buttons to navigate through the menu list. When an item is highlighted, a border will appear around it.
- To select a highlighted item, press the OK button. The screen will change depending on your selection.
- To return to the previous screen, press the Back button.

### Initial Setup

When you turn your BDS receiver on for the first time, the on-screen menu will display the Initial Setup screens. The first screen lets you set the language you want the BDS receiver to use.



Press the OK button, and the Initial Setup introduction screen will appear.

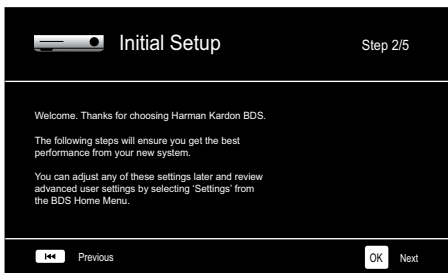

Press the OK button, and the Initial Setup TV resolution screen will appear.

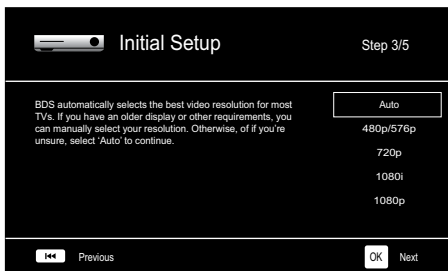

After selecting your TV's resolution, press the OK button, and the Initial Setup aspect-ratio screen will appear.

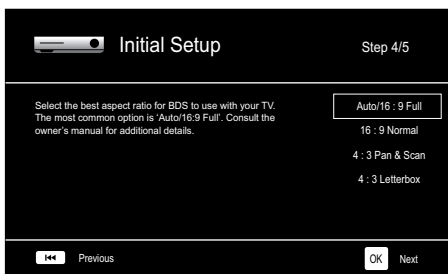

After selecting the aspect ratio that best fits your TV, press the OK button and the Initial Setup speaker package screen will appear.



This setting enables processing in the BDS receiver that will maximize your system's audio performance. If you are using a Harman Kardon speaker package with your BDS receiver, select it's model number from the list. If you're not using a Harman Kardon speaker package, select "Other."

Press the OK button to save your settings and then press it again to exit the Initial Setup screens.

### Configure the Receiver for Your Speakers

Before you use your BDS receiver you need to configure it to work with your particular speaker system. The BDS receiver's EZSet/EQ™ system uses the supplied EzSet/EQ microphone to perform this important step automatically. Before beginning, be sure you have correctly connected your speakers to the BDS receiver. **IMPORTANT: Press the remote's "Disc" input button before performing the EZ Set/EQ procedure. The EZ Set/EQ procedure is only available when the Disc input is selected.**

1. Plug the supplied EzSet/EQ microphone into the BDS receiver's Headphone connector.

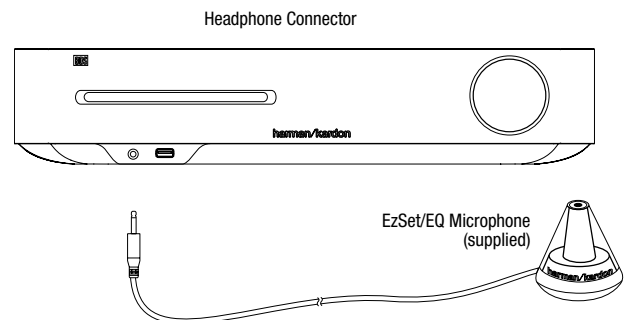

2. Place the microphone at ear height in your main listening position.
3. Press the remote control's Home button. The receiver's Home Menu screen will appear on the TV.

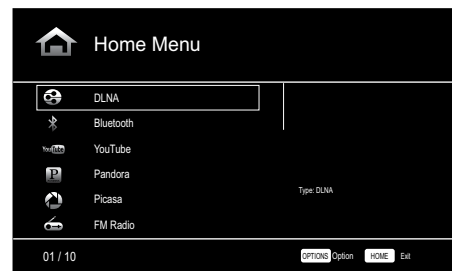

4. Use the Cursor and OK buttons to highlight and select Settings. The General Settings menu will appear.

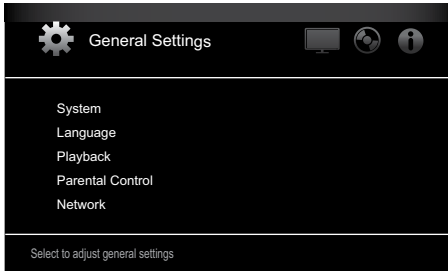

5. Use the right Cursor button to select Audio Settings, then use the down Cursor button to select Speaker Settings. The Speaker Settings screen will appear.

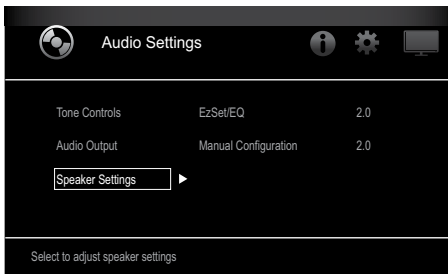

6. Press the right Cursor button to select EzSet/EQ, then use the cursor buttons to select the configuration of your speaker system.

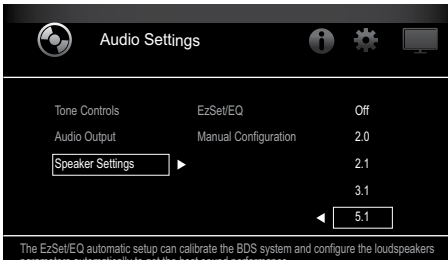

7. Press the OK button, then press it again to select Continue in the EzSet/EQ (Automatic Setup) box that appears.

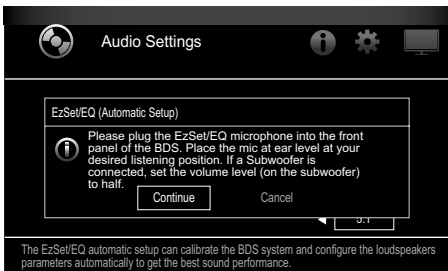

8. Remain silent while the test noise plays through the speakers. As the test noise circulates among the speakers the screen will show which speaker is being tested.

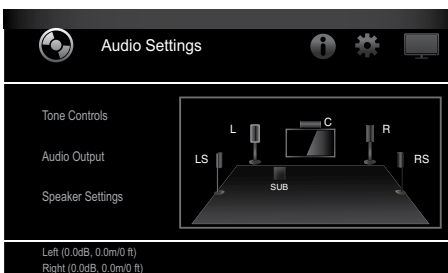

9. When the testing process is completed, the "Testing..." message on the screen will change to "All test done!"

10. Press the Back button to exit the EzSet/EQ test procedure.

**NOTE:** If the test fails, the "Testing..." message on the screen will change to "EzSet/EQ failed. Make sure all speakers are connected and the room is quiet then try again." Press the Back button, make sure all speakers are correctly connected and perform the test again from Step 6. Make sure that the room remains silent during the test.

### Using the BDS Receiver

Press the remote's Home button to display the Home Menu screen:

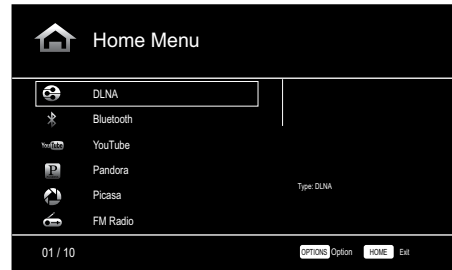

The available sources are listed on the left. If a disc has been inserted into the receiver's built-in disc slot, it will appear on the list as "Blu-ray Disc," "DVD Video", "CDDA" or "Data Disc" (audio or data CD-R disc). If you have inserted a USB device into the receiver's USB port, it will appear on the list as "USB."

**NOTE:** Digital and analog audio sources connected to the receiver's rear-panel optical digital, coaxial digital and analog inputs will not appear on the list but can be selected using the remote's "Aux" Source Selector button (see below).

To select a source from the list, use the Cursor Up/Down buttons to highlight the desired source, then press the OK button to select it.

You can also select some sources directly by pressing their Source Selector buttons on the remote.

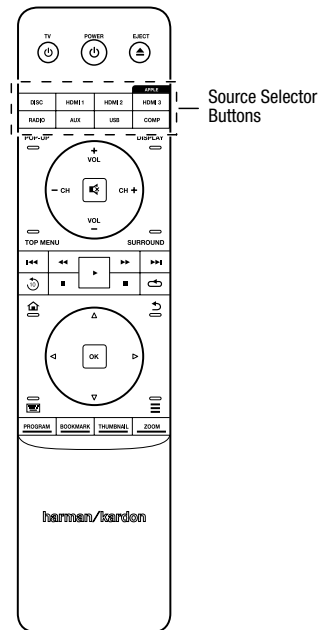

For complete information about using all of your BDS system's features, you can download the *BDS 275/BDS 277/BDS 575/BDS 577 Blu-ray Disc™ Receiver Owner's Manual* from [www.harmaninternational.com](http://www.harmaninternational.com).



**HARMAN**

HARMAN International Industries, Incorporated  
8500 Balboa Boulevard, Northridge, CA 91329 USA  
516.255.4545 (USA only)

Made in P.R.C.

© 2012 HARMAN International Industries, Incorporated. All rights reserved.

Harman Kardon is a trademark of HARMAN International Industries, Incorporated, registered in the United States and/or other countries. EzSet/EQ is a trademark of HARMAN International Industries, Incorporated. Blu-ray Disc and BD-Live are trademarks of the Blu-ray Disc Association. The Bluetooth word mark and logo are registered trademarks and are owned by the Bluetooth SIG, Inc., and any use of such marks by HARMAN International Industries, Incorporated, is under license. DIVX: ABOUT DIVX VIDEO: DivX® is a digital video format created by DivX, LLC, a subsidiary of Rovi Corporation. This is an official DivX Certified® device that plays DivX video. Visit [divx.com](http://divx.com) for more information and software tools to convert your files into DivX video. ABOUT DIVX® VIDEO-ON-DEMAND: This DivX Certified® device must be registered in order to play purchased DivX Video-on-Demand (VOD) movies. To obtain your registration code, locate the DivX VOD section in your device setup menu. Go to [vod.divx.com](http://vod.divx.com) for more information on how to complete your registration. DivX®, DivX Certified® and associated logos are trademarks of Rovi Corporation or its subsidiaries and are used under license. DivX Certified® to play DivX® video up to HD 1080p, including premium content. DLNA®, the DLNA Logo and DLNA CERTIFIED® are trademarks, service marks, or certification marks of the Digital Living Network Alliance. DOLBY DIGITAL PLUS TRUE-HD. Manufactured under license from Dolby Laboratories. Dolby and the double-D symbol are registered trademarks of Dolby Laboratories. DTS DIGITAL SURROUND. Manufactured under license under U.S. Patent # s: 5,956,674; 5,974,380; 6,487,535 & other U.S. and worldwide patents issued & pending. DTS, the Symbol and DTS and the Symbol together are registered trademarks, and DTS Digital Surround and the DTS logos are trademarks, of DTS, Inc. Product includes software. © DTS, Inc. All Rights Reserved. HDMI, the HDMI logo, and High-Definition Multimedia Interface are registered trademarks of HDMI Licensing LLC in the United States and other countries. iPhone, iPod and iPad are trademarks of Apple Inc., registered in the U.S. and other countries. iPod, iPhone and iPad not included. "Made for iPod," "Made for iPhone," and "Made for iPad" mean that an electronic accessory has been designed to connect specifically to iPod, iPhone, or iPad, respectively, and has been certified by the developer to meet Apple performance standards. Apple is not responsible for the operation of this device or its compliance with safety and regulatory standards. Please note that the use of this accessory with iPod, iPhone, or iPad may affect wireless performance. Java, Java Powered and the Java Steaming Coffee Cup logo are trademarks or registered trademarks of Sun Microsystems, Inc., or its subsidiaries in the United States and other countries. Microsoft, Windows and Windows Media are registered trademarks of Microsoft Corporation in the United States and/or other countries.

Pandora is a registered trademark of Pandora Media, Inc.

Picasa is a trademark of Google, Inc.

The Wi-Fi CERTIFIED Logo is a certification mark of the Wi-Fi Alliance.

WMA (Windows Media Audio) is a proprietary file format developed by Microsoft. This item incorporates copy-protection technology that is protected by U.S. patents and other intellectual-property rights of Rovi Corporation. Reverse engineering and disassembly are prohibited.

YouTube is a trademark of Google, Inc.

Features, specifications and appearance are subject to change without notice.

Part # 950-0466-001, Rev. A

**harman/kardon**  
by HARMAN

[www.harmankardon.com](http://www.harmankardon.com)